

Data sheet | Item number: 280-941/281-492

Component terminal block; double-deck; with 2 diodes 1N4007; Top anode, left-side anode; for DIN-rail 35 x 15 and 35 x 7.5; 2.5 mm²; CAGE CLAMP®

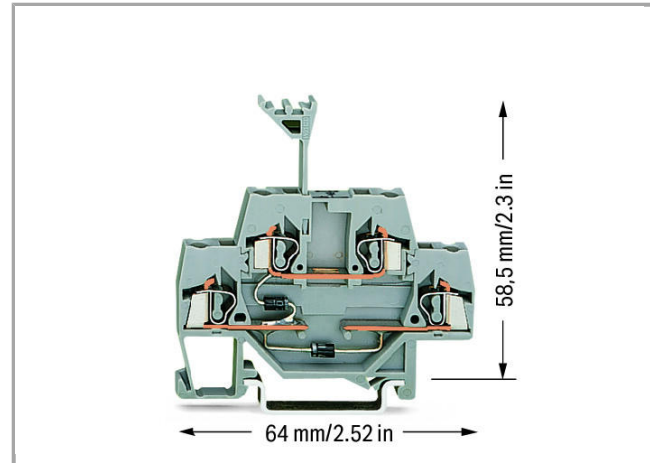

280-941/281-492

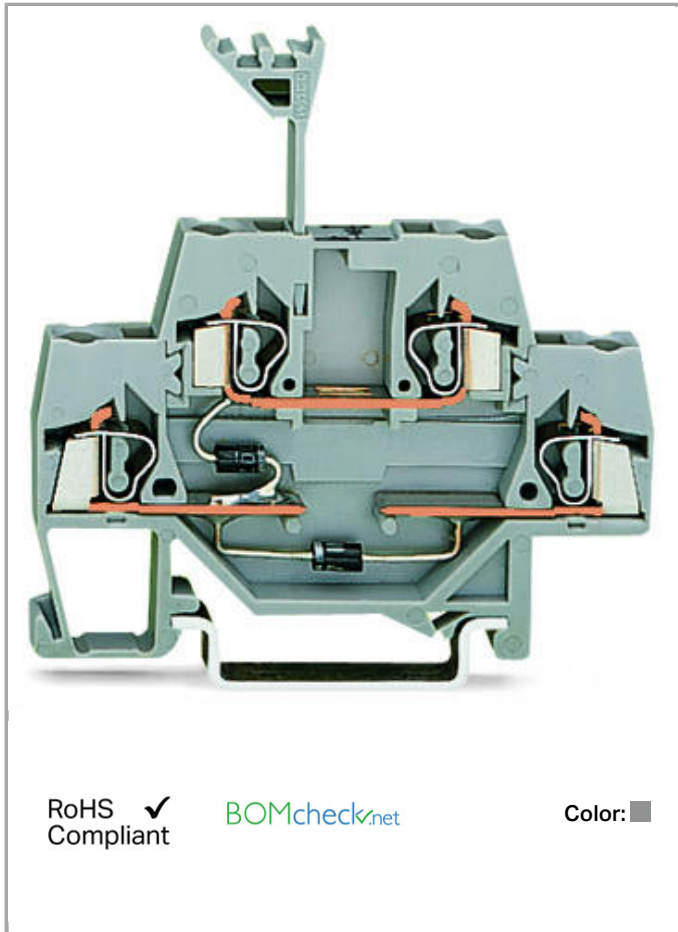

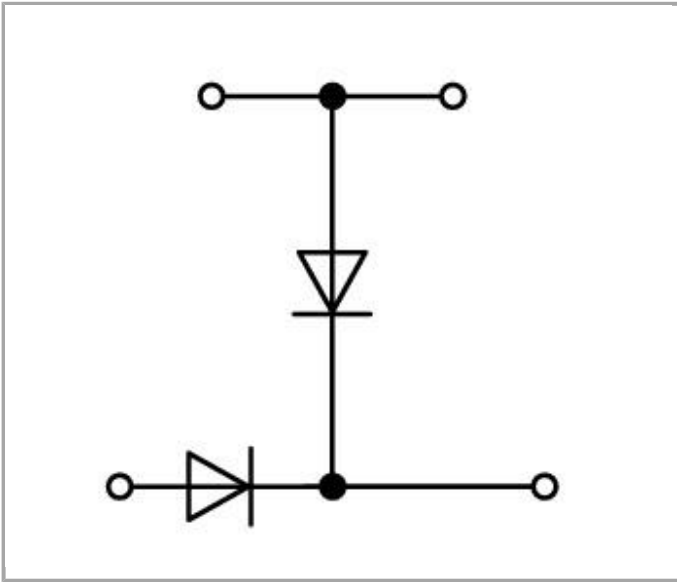

Item description

Note:

Terminating Aluminum Conductors

WAGO spring clamp terminal blocks are suitable for solid aluminum conductors up to 4 mm²/12 AWG if WAGO "Alu-Plus" Contact Paste is used for termination.

"Alu-Plus" Contact Paste Advantages:

- Automatically destroys the oxide film during clamping.
- Prevents fresh oxidation at the clamping point.
- Prevents electrolytic corrosion between aluminum and copper conductors (in the same terminal block).
- Provides long-term protection against corrosion.

Using terminal blocks with CAGE CLAMP® Spring Pressure Connection Technology, **aluminum conductors must first be cleaned with a blade** and then immediately be inserted into the clamping units filled with "Alu-Plus" Contact Paste.

It is also possible to apply WAGO "Alu-Plus" **additionally** on the whole surface of the aluminum conductor before termination.

Please note that the nominal currents must be adapted to the reduced conductivity of the aluminum conductors:

2.5 mm² (14 AWG) = 16 A

4 mm² (12 AWG) = 22 A

Data

Electrical data

Nominal voltage	250 V
Reverse voltage	1000 V

Ratings per IEC/EN 60664-1

Rated current	0.5 A
---------------	-------

Connection data

Connection technology	CAGE CLAMP®
Actuation type	Operating tool
Connectable conductor materials	Copper Aluminum
Solid conductor	0.08 ... 2.5 mm ² / 28 ... 14 AWG
Fine-stranded conductor	0.08 ... 2.5 mm ² / 28 ... 14 AWG
Strip length	8 ... 9 mm / 0.31 ... 0.35 inch
Total number of connection points	4
Total number of potentials	2
Number of levels	2
Type of wiring	Front-entry wiring

Geometrical Data

Width	5 mm / 0.197 inch
Height from upper-edge of DIN-35 rail	58.5 mm / 2.303 inch
Depth	64 mm / 2.52 inch

Mechanical data

Design	horizontal
Type of mounting	DIN-35 rail
Marking level	Center marking

Material Data











Color	gray
Insulating material	Polyamide 66 (PA 66)
Fire load	0.188 MJ
Weight	10.27 g















Commercial data















Product Group	1 (Rail Mounted Terminal Blocks)
Country of origin	DE
GTIN	4045454196714
Customs Tariff No.	85369010000

Compatible products

Female plug

	Item no.: 232-132/005-000 Female connector for rail-mount terminal blocks; straight; Pin spacing 5 mm; 2-pole	/005-000	232-132
	Item no.: 232-132/005-000/039-000 Female connector for rail-mount terminal blocks; straight; Locking lever; Pin spacing 5 mm; 3-pole	/005-000/039-000	232-132
	Item no.: 232-133/005-000 Female connector for rail-mount terminal blocks; straight; Pin spacing 5 mm; 3-pole	/005-000	232-133
	Item no.: 232-133/005-000/039-000 Female connector for rail-mount terminal blocks; straight; Locking lever; Pin spacing 5 mm; 3-pole	/005-000/039-000	232-133
	Item no.: 232-134/005-000 Female connector for rail-mount terminal blocks; straight; Pin spacing 5 mm; 4-pole	/005-000	232-134
	Item no.: 232-134/005-000/039-000 Female connector for rail-mount terminal blocks; straight; Locking lever; Pin spacing 5 mm; 4-pole	/005-000/039-000	232-134
	Item no.: 232-135/005-000 Female connector for rail-mount terminal blocks; straight; Pin spacing 5 mm; 5-pole	/005-000	232-135
	Item no.: 232-135/005-000/039-000 Female connector for rail-mount terminal blocks; straight; Locking lever; Pin spacing 5 mm; 5-pole	/005-000/039-000	232-135
	Item no.: 232-136/005-000 Female connector for rail-mount terminal blocks; straight; Pin spacing 5 mm; 6-pole	/005-000	232-136
	Item no.: 232-136/005-000/039-000 Female connector for rail-mount terminal blocks; straight; Locking lever; Pin spacing 5 mm; 6-pole	/005-000/039-000	232-136
	Item no.: 232-137/005-000 Female connector for rail-mount terminal blocks; straight; Pin spacing 5 mm; 7-pole	/005-000	232-137

	Item no.: 232-137/005-000/039-000 Female connector for rail-mount terminal blocks; straight; Locking lever; Pin spacing 5 mm; 7-pole	232-137 /005-000/039-000
	Item no.: 232-138/005-000 Female connector for rail-mount terminal blocks; straight; Pin spacing 5 mm; 8-pole	232-138 /005-000
	Item no.: 232-138/005-000/039-000 Female connector for rail-mount terminal blocks; straight; Locking lever; Pin spacing 5 mm; 8-pole	232-138 /005-000/039-000
	Item no.: 232-139/005-000 Female connector for rail-mount terminal blocks; straight; Pin spacing 5 mm; 9-pole	232-139 /005-000
	Item no.: 232-139/005-000/039-000 Female connector for rail-mount terminal blocks; straight; Locking lever; Pin spacing 5 mm; 9-pole	232-139 /005-000/039-000
	Item no.: 232-140/005-000 Female connector for rail-mount terminal blocks; straight; Pin spacing 5 mm; 10-pole	232-140 /005-000
	Item no.: 232-140/005-000/039-000 Female connector for rail-mount terminal blocks; straight; Locking lever; Pin spacing 5 mm; 10-pole	232-140 /005-000/039-000
	Item no.: 232-142/005-000 Female connector for rail-mount terminal blocks; straight; Pin spacing 5 mm; 12-pole	232-142 /005-000
	Item no.: 232-142/005-000/039-000 Female connector for rail-mount terminal blocks; straight; Locking lever; Pin spacing 5 mm; 12-pole	232-142 /005-000/039-000
	Item no.: 232-146/005-000 Female connector for rail-mount terminal blocks; straight; Pin spacing 5 mm; 16-pole	232-146 /005-000
	Item no.: 232-146/005-000/039-000 Female connector for rail-mount terminal blocks; straight; Locking lever; Pin spacing 5 mm; 16-pole	232-146 /005-000/039-000
	Item no.: 232-147/005-000/039-000 Female connector for rail-mount terminal blocks; straight; Locking lever; Pin spacing 5 mm; 17-pole	232-147 /005-000/039-000
	Item no.: 232-150/005-000 Female connector for rail-mount terminal blocks; straight; Pin spacing 5 mm; 20-pole	232-150 /005-000
	Item no.: 232-150/005-000/039-000 Female connector for rail-mount terminal blocks; straight; Locking lever; Pin spacing 5 mm; 20-pole	232-150 /005-000/039-000

	Item no.: 232-232/005-000 Female connector for rail-mount terminal blocks; angled; Pin spacing 5 mm; 2-pole	232-232 /005-000
	Item no.: 232-232/005-000/039-000 Female connector for rail-mount terminal blocks; angled; Locking lever; Pin spacing 5 mm; 2-pole	232-232 /005-000/039-000
	Item no.: 232-233/005-000 Female connector for rail-mount terminal blocks; angled; Pin spacing 5 mm; 3-pole	232-233 /005-000
	Item no.: 232-233/005-000/039-000 Female connector for rail-mount terminal blocks; angled; Locking lever; Pin spacing 5 mm; 3-pole	232-233 /005-000/039-000
	Item no.: 232-234/005-000 Female connector for rail-mount terminal blocks; angled; Pin spacing 5 mm; 4-pole	232-234 /005-000
	Item no.: 232-234/005-000/039-000 Female connector for rail-mount terminal blocks; angled; Locking lever; Pin spacing 5 mm; 4-pole	232-234 /005-000/039-000
	Item no.: 232-235/005-000 Female connector for rail-mount terminal blocks; angled; Pin spacing 5 mm; 5-pole	232-235 /005-000
	Item no.: 232-235/005-000/039-000 Female connector for rail-mount terminal blocks; angled; Locking lever; Pin spacing 5 mm; 5-pole	232-235 /005-000/039-000
	Item no.: 232-236/005-000 Female connector for rail-mount terminal blocks; angled; Pin spacing 5 mm; 6-pole	232-236 /005-000
	Item no.: 232-236/005-000/039-000 Female connector for rail-mount terminal blocks; angled; Locking lever; Pin spacing 5 mm; 6-pole	232-236 /005-000/039-000
	Item no.: 232-237/005-000 Female connector for rail-mount terminal blocks; straight; Pin spacing 5 mm; 7-pole	232-237 /005-000
	Item no.: 232-238/005-000 Female connector for rail-mount terminal blocks; angled; Pin spacing 5 mm; 8-pole	232-238 /005-000
	Item no.: 232-239/005-000 Female connector for rail-mount terminal blocks; angled; Pin spacing 5 mm; 9-pole	232-239 /005-000
	Item no.: 232-240/005-000 Female connector for rail-mount terminal blocks; angled; Pin spacing 5 mm; 10-pole	232-240 /005-000
	Item no.: 232-240/005-000/039-000 Female connector for rail-mount terminal blocks; angled; Locking lever; Pin spacing 5 mm; 10-pole	232-240 /005-000/039-000

**Item no.: 232-242/005-000**

Female connector for rail-mount terminal blocks; angled; Pin spacing 5 mm; 12-pole

/005-000

232-242

Item no.: 232-242/005-000/039-000

Female connector for rail-mount terminal blocks; angled; Locking lever; Pin spacing 5 mm; 12-pole

/005-000/039-000

232-242

Item no.: 232-246/005-000

Female connector for rail-mount terminal blocks; angled; Pin spacing 5 mm; 16-pole

/005-000

232-246

Item no.: 232-246/005-000/039-000

Female connector for rail-mount terminal blocks; angled; Locking lever; Pin spacing 5 mm; 16-pole

/005-000/039-000

232-246

Item no.: 232-250/005-000

Female connector for rail-mount terminal blocks; angled; Pin spacing 5 mm; 20-pole

/005-000

232-250

Item no.: 232-250/005-000/039-000

Female connector for rail-mount terminal blocks; angled; Locking lever; Pin spacing 5 mm; 20-pole

/005-000/039-000

232-250

Item no.: 232-732/005-000

Female connector for rail-mount terminal blocks; straight; Pin spacing 7.5 mm; 2-pole

/005-000

232-732

Item no.: 232-733/005-000

Female connector for rail-mount terminal blocks; straight; Pin spacing 7.5 mm; 3-pole

/005-000

232-733

Item no.: 232-734/005-000

Female connector for rail-mount terminal blocks; straight; Pin spacing 7.5 mm; 4-pole

/005-000

232-734

Item no.: 232-734/005-000/039-000

Female connector for rail-mount terminal blocks; straight; Pin spacing 7.5 mm; 4-pole

/005-000/039-000

232-734

Item no.: 232-735/005-000

Female connector for rail-mount terminal blocks; straight; Pin spacing 7.5 mm; 5-pole

/005-000

232-735

Item no.: 232-735/005-000/039-000

Female connector for rail-mount terminal blocks; straight; Pin spacing 7.5 mm; 5-pole

/005-000/039-000

232-735

Item no.: 232-736/005-000

Female connector for rail-mount terminal blocks; straight; Pin spacing 7.5 mm; 6-pole

/005-000















232-736

Item no.: 232-736/005-000/039-000















Female connector for rail-mount terminal blocks; straight; Pin spacing 7.5 mm; 6-pole















/005-000/039-000















232-736















	Item no.: 232-738/005-000 Female connector for rail-mount terminal blocks; straight; Pin spacing 7.5 mm; 8-pole	232-738 /UU5-UUU
	Item no.: 232-740/005-000 Female connector for rail-mount terminal blocks; straight; Pin spacing 7.5 mm; 10-pole	232-740 /UU5-UUU
	Item no.: 232-742/005-000 Female connector for rail-mount terminal blocks; straight; Pin spacing 7.5 mm; 12-pole	232-742 /UU5-UUU
	Item no.: 232-832/005-000 Female connector for rail-mount terminal blocks; angled; Pin spacing 7.5 mm; 2-pole	232-832 /UU5-UUU
	Item no.: 232-833/005-000 Female connector for rail-mount terminal blocks; angled; Pin spacing 7.5 mm; 3-pole	232-833 /UU5-UUU
	Item no.: 232-834/005-000 Female connector for rail-mount terminal blocks; angled; Pin spacing 7.5 mm; 4-pole	232-834 /UU5-UUU
	Item no.: 232-836/005-000 Female connector for rail-mount terminal blocks; straight; Pin spacing 7.5 mm; 6-pole	232-836 /UU5-UUU
	Item no.: 232-836/005-000/039-000 Female connector for rail-mount terminal blocks; angled; Pin spacing 7.5 mm; 6-pole	232-836 /UU5-UUU/039-U00
	Item no.: 232-840/005-000 Female connector for rail-mount terminal blocks; straight; Pin spacing 7.5 mm; 10-pole	232-840 /UU5-UUU
	Item no.: 232-842/005-000 Female connector for rail-mount terminal blocks; straight; Pin spacing 7.5 mm; 12-pole	232-842 /UU5-UUU
	Item no.: 722-132/005-000 Female connector for rail-mount terminal blocks; straight; 100% protected against mismatching; Pin spacing 5 mm; 2-pole	722-132 /UU5-UUU
	Item no.: 722-132/005-000/039-000 Female connector for rail-mount terminal blocks; straight; 100% protected against mismatching; Locking lever; Pin spacing 5 mm; 3-pole	722-132 /UU5-UUU/039-U00
	Item no.: 722-133/005-000 Female connector for rail-mount terminal blocks; straight; 100% protected against mismatching; Pin spacing 5 mm; 3-pole	722-133 /UU5-UUU
	Item no.: 722-133/005-000/039-000 Female connector for rail-mount terminal blocks; straight; 100% protected against mismatching; Locking lever; Pin spacing 5 mm; 3-pole	722-133 /UU5-UUU/039-U00
	Item no.: 722-134/005-000 Female connector for rail-mount terminal blocks; straight; 100% protected against mismatching; Pin spacing 5 mm; 3-pole	722-134 /UU5-UUU















spacing 5 mm; 4-pole















	Item no.: 722-134/005-000/039-000 Female connector for rail-mount terminal blocks; straight; 100% protected against mismatching; Locking lever; Pin spacing 5 mm; 4-pole	722-134 /005-000/039-000
	Item no.: 722-135/005-000 Female connector for rail-mount terminal blocks; straight; 100% protected against mismatching; Pin spacing 5 mm; 5-pole	722-135 /005-000
	Item no.: 722-135/005-000/039-000 Female connector for rail-mount terminal blocks; straight; 100% protected against mismatching; Locking lever; Pin spacing 5 mm; 5-pole	722-135 /005-000/039-000
	Item no.: 722-136/005-000 Female connector for rail-mount terminal blocks; straight; 100% protected against mismatching; Pin spacing 5 mm; 6-pole	722-136 /005-000
	Item no.: 722-136/005-000/039-000 Female connector for rail-mount terminal blocks; straight; 100% protected against mismatching; Locking lever; Pin spacing 5 mm; 6-pole	722-136 /005-000/039-000
	Item no.: 722-137/005-000 Female connector for rail-mount terminal blocks; straight; 100% protected against mismatching; Pin spacing 5 mm; 7-pole	722-137 /005-000
	Item no.: 722-137/005-000/039-000 Female connector for rail-mount terminal blocks; straight; 100% protected against mismatching; Locking lever; Pin spacing 5 mm; 7-pole	722-137 /005-000/039-000
	Item no.: 722-138/005-000 Female connector for rail-mount terminal blocks; straight; 100% protected against mismatching; Pin spacing 5 mm; 8-pole	722-138 /005-000
	Item no.: 722-138/005-000/039-000 Female connector for rail-mount terminal blocks; straight; 100% protected against mismatching; Locking lever; Pin spacing 5 mm; 8-pole	722-138 /005-000/039-000
	Item no.: 722-139/005-000 Female connector for rail-mount terminal blocks; straight; 100% protected against mismatching; Pin spacing 5 mm; 9-pole	722-139 /005-000
	Item no.: 722-139/005-000/039-000 Female connector for rail-mount terminal blocks; straight; 100% protected against mismatching; Locking lever; Pin spacing 5 mm; 9-pole	722-139 /005-000/039-000
	Item no.: 722-140/005-000 Female connector for rail-mount terminal blocks; straight; 100% protected against mismatching; Pin spacing 5 mm; 10-pole	722-140 /005-000
	Item no.: 722-140/005-000/039-000 Female connector for rail-mount terminal blocks; straight; 100% protected against mismatching; Locking lever; Pin spacing 5 mm; 10-pole	722-140 /005-000/039-000
	Item no.: 722-141/005-000 Female connector for rail-mount terminal blocks; straight; 100% protected against mismatching; Pin spacing 5 mm; 11-pole	722-141 /005-000
	Item no.: 722-142/005-000	

















	Female connector for rail-mount terminal blocks; straight; 100% protected against mismatching; Pin spacing 5 mm; 12-pole	722-142 /005-000
	Item no.: 722-142/005-007/039-000 Female connector for rail-mount terminal blocks; straight; 100% protected against mismatching; Locking lever; Pin spacing 5 mm; 12-pole	722-142 /005-007/039-000
	Item no.: 722-143/005-000 Female connector for rail-mount terminal blocks; angled; 100% protected against mismatching; Pin spacing 5 mm; 13-pole	722-143 /005-000
	Item no.: 722-144/005-000 Female connector for rail-mount terminal blocks; straight; 100% protected against mismatching; Pin spacing 5 mm; 14-pole	722-144 /005-000
	Item no.: 722-144/005-000/039-000 Female connector for rail-mount terminal blocks; straight; 100% protected against mismatching; Locking lever; Pin spacing 5 mm; 14-pole	722-144 /005-000/039-000
	Item no.: 722-145/005-000 Female connector for rail-mount terminal blocks; straight; 100% protected against mismatching; Pin spacing 5 mm; 15-pole	722-145 /005-000
	Item no.: 722-146/005-000 Female connector for rail-mount terminal blocks; straight; 100% protected against mismatching; Pin spacing 5 mm; 16-pole	722-146 /005-000
	Item no.: 722-146/005-000/039-000 Female connector for rail-mount terminal blocks; straight; 100% protected against mismatching; Locking lever; Pin spacing 5 mm; 16-pole	722-146 /005-000/039-000
	Item no.: 722-150/005-000 Female connector for rail-mount terminal blocks; straight; 100% protected against mismatching; Pin spacing 5 mm; 20-pole	722-150 /005-000
	Item no.: 722-150/005-000/039-000 Female connector for rail-mount terminal blocks; straight; 100% protected against mismatching; Locking lever; Pin spacing 5 mm; 20-pole	722-150 /005-000/039-000
	Item no.: 722-232/005-000 Female connector for rail-mount terminal blocks; angled; 100% protected against mismatching; Pin spacing 5 mm; 3-pole	722-232 /005-000
	Item no.: 722-232/005-000/039-000 Female connector for rail-mount terminal blocks; straight; 100% protected against mismatching; Locking lever; Pin spacing 5 mm; 3-pole	722-232 /005-000/039-000
	Item no.: 722-233/005-000 Female connector for rail-mount terminal blocks; angled; 100% protected against mismatching; Pin spacing 5 mm; 3-pole	722-233 /005-000
	Item no.: 722-233/005-000/039-000 Female connector for rail-mount terminal blocks; angled; 100% protected against mismatching; Locking lever; Pin spacing 5 mm; 3-pole	722-233 /005-000/039-000
	Item no.: 722-234/005-000 Female connector for rail-mount terminal blocks; angled; 100% protected against mismatching; Pin spacing 5 mm; 4-pole	722-234 /005-000

















	Item no.: 722-234/005-000/039-000 Female connector for rail-mount terminal blocks; straight; 100% protected against mismatching; Locking lever; Pin spacing 5 mm; 4-pole	722-234 /005-000/039-000
	Item no.: 722-235/005-000 Female connector for rail-mount terminal blocks; angled; 100% protected against mismatching; Pin spacing 5 mm; 5-pole	722-235 /005-000
	Item no.: 722-235/005-000/039-000 Female connector for rail-mount terminal blocks; angled; 100% protected against mismatching; Locking lever; Pin spacing 5 mm; 5-pole	722-235 /005-000/039-000
	Item no.: 722-236/005-000 Female connector for rail-mount terminal blocks; angled; 100% protected against mismatching; Pin spacing 5 mm; 6-pole	722-236 /005-000
	Item no.: 722-236/005-000/039-000 Female connector for rail-mount terminal blocks; angled; 100% protected against mismatching; Locking lever; Pin spacing 5 mm; 6-pole	722-236 /005-000/039-000
	Item no.: 722-237/005-000 Female connector for rail-mount terminal blocks; angled; 100% protected against mismatching; Pin spacing 5 mm; 7-pole	722-237 /005-000
	Item no.: 722-237/005-000/039-000 Female connector for rail-mount terminal blocks; angled; 100% protected against mismatching; Locking lever; Pin spacing 5 mm; 7-pole	722-237 /005-000/039-000
	Item no.: 722-238/005-000 Female connector for rail-mount terminal blocks; angled; 100% protected against mismatching; Pin spacing 5 mm; 8-pole	722-238 /005-000
	Item no.: 722-239/005-000 Female connector for rail-mount terminal blocks; angled; 100% protected against mismatching; Pin spacing 5 mm; 9-pole	722-239 /005-000
	Item no.: 722-239/005-000/039-000 Female connector for rail-mount terminal blocks; angled; 100% protected against mismatching; Locking lever; Pin spacing 5 mm; 9-pole	722-239 /005-000/039-000
	Item no.: 722-240/005-000 Female connector for rail-mount terminal blocks; angled; 100% protected against mismatching; Pin spacing 5 mm; 10-pole	722-240 /005-000
	Item no.: 722-240/005-000/039-000 Female connector for rail-mount terminal blocks; angled; 100% protected against mismatching; Locking lever; Pin spacing 5 mm; 10-pole	722-240 /005-000/039-000
	Item no.: 722-241/005-000 Female connector for rail-mount terminal blocks; straight; 100% protected against mismatching; Pin spacing 5 mm; 11-pole	722-241 /005-000
	Item no.: 722-242/005-000 Female connector for rail-mount terminal blocks; angled; 100% protected against mismatching; Pin spacing 5 mm; 12-pole	722-242 /005-000
	Item no.: 722-242/005-000/039-000	



















	Female connector for rail-mount terminal blocks; angled; 100% protected against mismatching; Locking lever; Pin spacing 5 mm; 12-pole	722-242 /005-000/039-000
	Item no.: 722-243/005-000 Female connector for rail-mount terminal blocks; angled; 100% protected against mismatching; Pin spacing 5 mm; 13-pole	722-243 /005-000
	Item no.: 722-244/005-000 Female connector for rail-mount terminal blocks; angled; 100% protected against mismatching; Pin spacing 5 mm; 14-pole	722-244 /005-000
	Item no.: 722-244/005-000/039-000 Female connector for rail-mount terminal blocks; angled; 100% protected against mismatching; Locking lever; Pin spacing 5 mm; 14-pole	722-244 /005-000/039-000
	Item no.: 722-246/005-000 Female connector for rail-mount terminal blocks; angled; 100% protected against mismatching; Pin spacing 5 mm; 16-pole	722-246 /005-000
	Item no.: 722-246/005-000/039-000 Female connector for rail-mount terminal blocks; angled; 100% protected against mismatching; Locking lever; Pin spacing 5 mm; 16-pole	722-246 /005-000/039-000
	Item no.: 722-250/005-000 Female connector for rail-mount terminal blocks; angled; 100% protected against mismatching; Pin spacing 5 mm; 20-pole	722-250 /005-000
General accessories		
	Item no.: 231-162/003-000 Male connector for rail-mount terminal blocks; 1.2 x 1.2 mm pins; straight; Pin spacing 5 mm; 2-pole	231-162 /003-000
	Item no.: 231-163/003-000 Male connector for rail-mount terminal blocks; 1.2 x 1.2 mm pins; straight; Pin spacing 5 mm; 3-pole	231-163 /003-000
	Item no.: 231-164/003-000 Male connector for rail-mount terminal blocks; 1.2 x 1.2 mm pins; straight; Pin spacing 5 mm; 4-pole	231-164 /003-000
	Item no.: 231-165/003-000 Male connector for rail-mount terminal blocks; 1.2 x 1.2 mm pins; straight; Pin spacing 5 mm; 5-pole	231-165 /003-000
	Item no.: 231-166/003-000 Male connector for rail-mount terminal blocks; 1.2 x 1.2 mm pins; straight; Pin spacing 5 mm; 6-pole	231-166 /003-000
	Item no.: 231-167/003-000 Male connector for rail-mount terminal blocks; 1.2 x 1.2 mm pins; straight; Pin spacing 5 mm; 7-pole	231-167 /003-000
	Item no.: 231-168/003-000 Male connector for rail-mount terminal blocks; 1.2 x 1.2 mm pins; straight; Pin spacing 5 mm; 8-pole	231-168 /003-000

	Item no.: 231-169/003-000 Male connector for rail-mount terminal blocks; 1.2 x 1.2 mm pins; straight; Pin spacing 5 mm; 9-pole / 003-000	231-169
	Item no.: 231-170/003-000 Male connector for rail-mount terminal blocks; 1.2 x 1.2 mm pins; straight; Pin spacing 5 mm; 10-pole / 003-000	231-170
	Item no.: 231-171/003-000 Male connector for rail-mount terminal blocks; 1.2 x 1.2 mm pins; straight; Pin spacing 5 mm; 11-pole / 003-000	231-171
	Item no.: 231-172/003-000 Male connector for rail-mount terminal blocks; 1.2 x 1.2 mm pins; straight; Pin spacing 5 mm; 12-pole / 003-000	231-172
	Item no.: 231-176/003-000 Male connector for rail-mount terminal blocks; 1.2 x 1.2 mm pins; straight; Pin spacing 5 mm; 16-pole / 003-000	231-176
	Item no.: 231-180/003-000 Male connector for rail-mount terminal blocks; 1.2 x 1.2 mm pins; straight; Pin spacing 5 mm; 20-pole / 003-000	231-180
	Item no.: 231-668 Lockout caps; for covering unused clamping units	231-668
	Item no.: 231-669 Lockout caps; for covering unused clamping units	231-669
	Item no.: 249-105 Group marker carrier	249-105
Marking accessories		
	Item no.: 2009-115 WMB-Inline; for Smart Printer; on reel; stretchable 5 - 5.2 mm; plain; snap-on type	2009-115
	Item no.: 2009-115/000-002 WMB-Inline; for Smart Printer; on reel; stretchable 5 - 5.2 mm; plain; snap-on type / 000-002	2009-115
	Item no.: 2009-115/000-006 WMB-Inline; for smartPRINTER; on reel; stretchable 5 - 5.2 mm; plain; snap-on type / 000-006	2009-115
	Item no.: 2009-115/000-007 WMB-Inline; for Smart Printer; on reel; stretchable 5 - 5.2 mm; plain; snap-on type / 000-007	2009-115
	Item no.: 2009-115/000-012 WMB-Inline; for smartPRINTER; on reel; stretchable 5 - 5.2 mm; plain; snap-on type / 000-012	2009-115
	Item no.: 2009-115/000-017 WMB-Inline; for Smart Printer; on reel; stretchable 5 - 5.2 mm; plain; snap-on type / 000-017	2009-115

	Item no.: 2009-115/000-023 WMB-Inline; for Smart Printer; on reel; stretchable 5 - 5.2 mm; plain; snap-on type	2009-115
		/000-023
	Item no.: 2009-115/000-024 WMB-Inline; for smartPRINTER; on reel; stretchable 5 - 5.2 mm; plain; snap-on type	2009-115
		/000-024
	Item no.: 793-501 WMB marking card; as card; not stretchable; plain; snap-on type	793-501
	Item no.: 793-501/000-002 WMB marking card; as card; not stretchable; plain; snap-on type	793-501
		/000-002
	Item no.: 793-501/000-005 WMB marking card; as card; not stretchable; plain; snap-on type	793-501
		/000-005
	Item no.: 793-501/000-006 WMB marking card; as card; not stretchable; plain; snap-on type	793-501
		/000-006
	Item no.: 793-501/000-007 WMB marking card; as card; not stretchable; plain; snap-on type	793-501
		/000-007
	Item no.: 793-501/000-012 WMB marking card; as card; not stretchable; plain; snap-on type	793-501
		/000-012
	Item no.: 793-501/000-017 WMB marking card; as card; not stretchable; plain; snap-on type	793-501
		/000-017
	Item no.: 793-501/000-023 WMB marking card; as card; not stretchable; plain; snap-on type	793-501
		/000-023
	Item no.: 793-501/000-024 WMB marking card; as card; not stretchable; plain; snap-on type	793-501
		/000-024
	Item no.: 793-5501 WMB marking card; as card; for terminal block width 5 - 17.5 mm; stretchable 5 - 5.2 mm; plain; snap-on type	793-5501
	Item no.: 793-5501/000-002 WMB marking card; as card; for terminal block width 5 - 17.5 mm; stretchable 5 - 5.2 mm; plain; snap-on type	793-5501
		/000-002
	Item no.: 793-5501/000-005 WMB marking card; as card; stretchable 5 - 5.2 mm; plain; snap-on type	793-5501
		/000-005
	Item no.: 793-5501/000-006 WMB marking card; as card; stretchable 5 - 5.2 mm; plain; snap-on type	793-5501
		/000-006

	Item no.: 793-5501/000-007 WMB marking card; as card; stretchable 5 - 5.2 mm; plain; snap-on type	/000-007	793-5501
	Item no.: 793-5501/000-012 WMB marking card; as card; stretchable 5 - 5.2 mm; plain; snap-on type	/000-012	793-5501
	Item no.: 793-5501/000-017 WMB marking card; as card; stretchable 5 - 5.2 mm; plain; snap-on type	/000-017	793-5501
	Item no.: 793-5501/000-023 WMB marking card; as card; stretchable 5 - 5.2 mm; plain; snap-on type	/000-023	793-5501
	Item no.: 793-5501/000-024 WMB marking card; as card; stretchable 5 - 5.2 mm; plain; snap-on type	/000-024	793-5501
check			
	Item no.: 249-141 L-type test plug module; modular; with spring-loaded contact pin; Center module		249-141
Carrier rail			
	Item no.: 210-112 Steel carrier rail; 35 x 7.5 mm; 1 mm thick; 2 m long; slotted; according to EN 60715; "Hole width 25 mm		210-112
	Item no.: 210-113 Steel carrier rail; 35 x 7.5 mm; 1 mm thick; 2 m long; unslotted; according to EN 60715		210-113
	Item no.: 210-114 Steel carrier rail; 35 x 15 mm; 1.5 mm thick; 2 m long; unslotted; similar to EN 60715		210-114
	Item no.: 210-115 Steel carrier rail; 35 x 7.5 mm; 1 mm thick; 2 m long; slotted; according to EN 60715; "Hole width 18 mm		210-115
	Item no.: 210-118 Steel carrier rail; 35 x 15 mm; 2.3 mm thick; 2 m long; unslotted; according to EN 60715		210-118
	Item no.: 210-196 Aluminum carrier rail; 35 x 8.2 mm; 1.6 mm thick; 2 m long; unslotted; similar to EN 60715		210-196
	Item no.: 210-197 Steel carrier rail; 35 x 15 mm; 1.5 mm thick; 2 m long; slotted; similar to EN 60715		210-197
	Item no.: 210-198 Copper carrier rail; 35 x 15 mm; 2.3 mm thick; 2 m long; unslotted; according to EN 60715		210-198
	Item no.: 210-504 Steel carrier rail; 35 x 7.5 mm; 1 mm thick; 2 m long; slotted; galvanized; according to EN 60715		210-504
	Item no.: 210-505 Steel carrier rail; 35 x 7.5 mm; 1 mm thick; 2 m long; unslotted; galvanized; according to EN 60715		210-505
	Item no.: 210-506 Steel carrier rail; 35 x 15 mm; 1.5 mm thick; 2 m long; unslotted; galvanized; similar to EN 60715		210-506

	Item no.: 210-508 Steel carrier rail; 35 x 15 mm; 1.5 mm thick; 2 m long; slotted; galvanized; similar to EN 60715	210-508
assembling		
	Item no.: 209-106 Mounting carrier; for isolated mounting on DIN 35 rails	209-106
	Item no.: 709-154 Cover; Type 2; suitable for cover carrier, type 2; 1 m long	709-154
Protective Warning Marker		
	Item no.: 280-415 Protective warning marker; with high-voltage symbol, black; for 5 terminal blocks	280-415
tools		
	Item no.: 210-657 Operating tool with partially insulated shaft; Blade (3.5 x 0.5) mm; short	210-657
	Item no.: 210-658 Operating tool with partially insulated shaft; Blade (3.5 x 0.5) mm; short; angled	210-658
	Item no.: 210-720 Operating tool with partially insulated shaft; Type 2, blade (3.5 x 0.5) mm	210-720
Insulation stop		
	Item no.: 280-470 Insulation stop; 0.08 - 0.2 mm ² "s" (0.14 mm ² "f-st"); 5 pieces/strip	280-470
	Item no.: 280-471 Insulation stop; 0.25 - 0.5 mm ² ; 5 pieces/strip	280-471
	Item no.: 280-472 Insulation stop; 0.75 - 1 mm ² ; 5 pieces/strip	280-472
End plate		
	Item no.: 209-192 Separator for Ex e/Ex i applications; 3 mm thick; 125.5 mm wide	209-192
	Item no.: 280-340 End and intermediate plate; 2.5 mm thick	280-340
	Item no.: 280-341 End and intermediate plate; 2.5 mm thick	280-341
Jumper		
	Item no.: 210-103 Wire commoning chain; insulated; 50 connections	210-103
	Item no.: 210-123 Wire commoning chain; insulated; 50 connections	210-123
	Item no.: 249-123 Push-in type wire jumper; insulated; wire length 180 mm; Conductor cross section 0.75 mm ²	249-123
	Item no.: 249-125 Push-in type wire jumper; insulated; wire length 60 mm; Conductor cross section 0.75 mm ²	249-125
	Item no.: 249-126	

	Push-in type wire jumper; insulated; wire length 110 mm; Conductor cross section 0.75 mm ²	249-126
	Item no.: 249-127 Push-in type wire jumper; insulated; wire length 250 mm; Conductor cross section 0.75 mm ²	249-127
	Item no.: 280-482 Comb-style jumper bar; insulated; 2-way; IN = IN terminal block	280-482
	Item no.: 280-483 Comb-style jumper bar; insulated; 3-way; IN = IN terminal block	280-483
	Item no.: 280-484 Comb-style jumper bar; insulated; 4-way; IN = IN terminal block	280-484
	Item no.: 280-485 Comb-style jumper bar; insulated; 5-way; IN = IN terminal block	280-485
	Item no.: 280-490 Comb-style jumper bar; insulated; 10-way; IN = IN terminal block	280-490
	Item no.: 280-492 Alternate comb-style jumper bar; insulated; 2-way; IN = IN terminal block	280-492
	Item no.: 709-110 Wire commoning chain; insulated; 4 connections; 3 x 110 mm	709-110
	Item no.: 709-111 Wire commoning chain; insulated; 3 connections; 2 x 120 mm	709-111
	Item no.: 709-112 Wire commoning chain; insulated; 3 connections; 2 x 170 mm	709-112
ferrule		
	Item no.: 216-101 Ferrule; Sleeve for 0.5 mm ² / AWG 22; uninsulated; electro-tin plated	216-101
	Item no.: 216-102 Ferrule; Sleeve for 0.75 mm ² / AWG 20; uninsulated; electro-tin plated	216-102
	Item no.: 216-103 Ferrule; Sleeve for 1 mm ² / AWG 18; uninsulated; electro-tin plated	216-103
	Item no.: 216-104 Ferrule; Sleeve for 1.5 mm ² / AWG 16; uninsulated; electro-tin plated	216-104
	Item no.: 216-201 Ferrule; Sleeve for 0.5 mm ² / 20 AWG; insulated; electro-tin plated	216-201
	Item no.: 216-202 Ferrule; Sleeve for 0.75 mm ² / 18 AWG; insulated; electro-tin plated	216-202
	Item no.: 216-203 Ferrule; Sleeve for 1 mm ² / AWG 18; insulated; electro-tin plated	216-203
	Item no.: 216-204 Ferrule; Sleeve for 1.5 mm ² / AWG 16; insulated; electro-tin plated	216-204
	Item no.: 216-301	216-301

Ferrule; Sleeve for 0.25 mm² / AWG 24; insulated; electro-tin plated



Item no.: 216-302

Ferrule; Sleeve for 0.34 mm² / 22 AWG; insulated; electro-tin plated

216-302

Downloads

Documentation

Bid Text

280-941/281-492

doc
25.1 kB

[Download](#)

CAD/CAE - Smart Data

CAD data

3D Download 280-941/281-492

[URL](#)

[Download](#)

Subject to changes.